

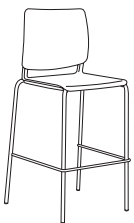

MELITA stacking/stool chair *datasheet*

Extent of Range

Melita 4 leg, Wire and Stool stacking chair with arm option.

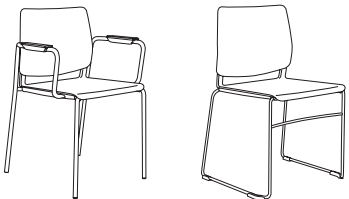
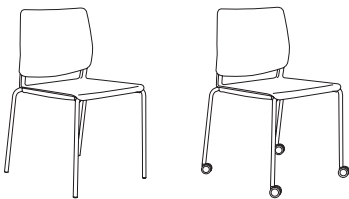

Product Warranty

Limited Lifetime

4 Leg/Sled & Stool Frame Features

Back: Solid Plastic curved back in a range of colors.

Seat: Plastic seat in a range of colors or upholstered in vinyl or fabric with 1" thick High Resilient foam.

4 Leg Frame: Type: High density stacking multi-use chairs. 12 gauge, 18mm round tube base with black plastic glides finished in chrome, silver or black. Caster option available using 50mm casters.

Optional Arms" Closed loop arm with plastic armrests to match the back color.

Sled Frame: Type: High density stacking multi-use chairs. 11mm steel rod with clear glides and finished in chrome.

Stool 4 Leg Frame: Type: Stacking stool chair, 12 gauge, 18mm round tube base with black plastic glides finished in chrome, silver or black.

Stacking

Sled and 4 Leg Frame Stacks 6 on the floor with plastic seat and 3 on the floor with upholstered seat.

20 on the Cart with plastic and upholstered seat.

Stool stacks 3 on the floor with plastic seat and upholstered seat. Cart not available for stool.

Product Durability

Melita has been tested for durability, strength and safety requirements for commercial seating. 300 lb. capacity.

Environmental Manufacturing

Chair components manufactured from a blend of recycled materials at a minimum quantity of 30%

Any rejected plastic production waste is 100% recycled.

Shipping

The Melita is delivered pre-assembled by the OCI Team of assemblers, bagged and wrapped for protection. Ships 2 to a carton or blanket wrapped where available.

Contact sales representative for more information.



MELITA stacking/stool chair *datasheet*

Dimensions

- Overall Width Without Arms: 19.75"
- Overall Width With Arms: 23"
- Overall Depth: 21"
- Overall Height Chair: 33.5"
- Overall Height Stool: 45"
- Seat Height Chair: 18"
- Seat Height Stool: 30"
- Stool Footrest Height from Floor: 12"

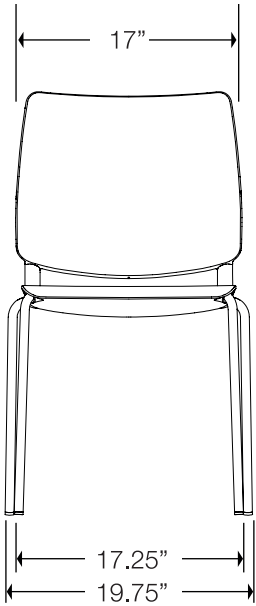
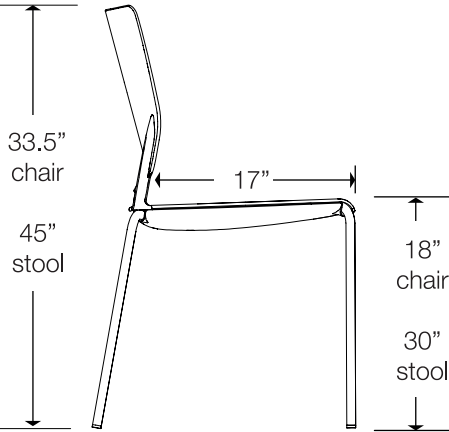

Materials

Polypropylene: Made of light weight Polypropylene molded and shaped to give an ergonomic seat. Material is UV rated to withstand fading in the sun.

Steel: 12 gauge, 18mm tube steel on 4 legged frame and the wire frame consists of 11mm steel rod both finished in Trivalent Chromium (tri-chrome) plating provides added protection extending the product life cycle.

Optional Fabric Seat Pad

Available in a range of graded in fabrics from group 1 - 8. Choose from Momentum, Mayer, CF Stinson and more available upon request.

Base Finishes

Standard

Optional

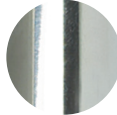

C - Chrome



S - Silver

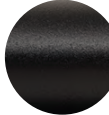

B - Black

Standard Plastic Colors



P10-Ebony



P20-Indigo



P30-Smoke



P40-Cotton

Special Order Plastic Colors



P50-Olive



P60-Apple



P70-Mocha

Please visit ociseating.com for additional product information.

